

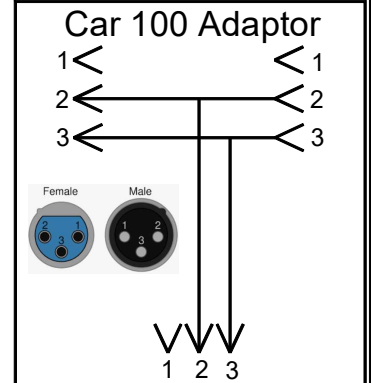

12 Volt Li-Ion
20 Amp-Hr

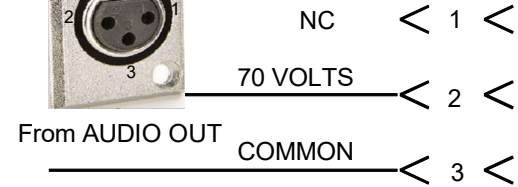
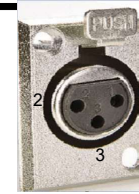

FUSE

Bridge Rectifier



To 12 Volt Input

5 Volts out



Polarity DOES NOT matter
The BRIDGE RECTIFIER takes care of this.

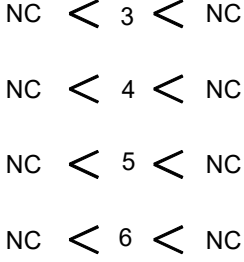

Car 100 Adaptor

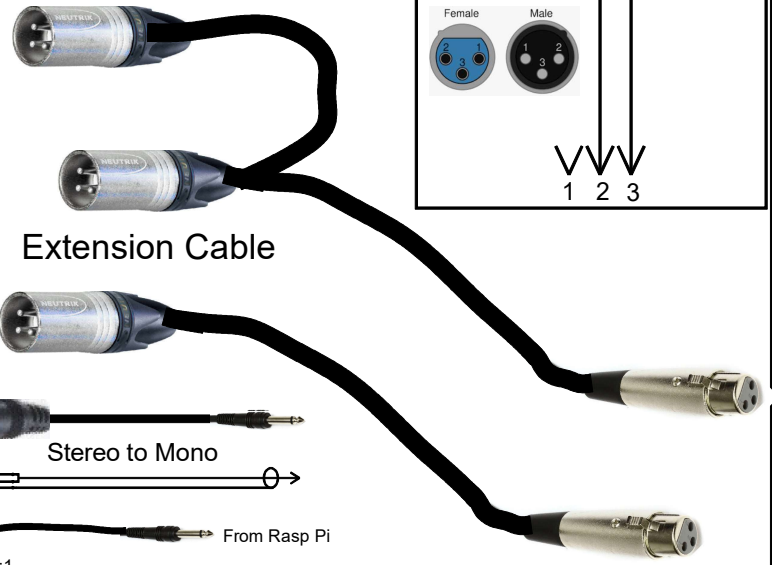

Extension Cable

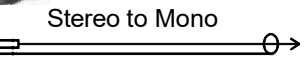

Stereo to Mono

To AUX In on PA-105 From Rasp Pi

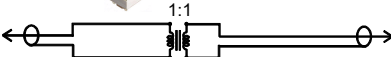

12 Volts DC

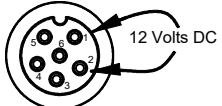

FUSE

- 5/25/22 Rev 1.2
Added the Car 100 Adaptor
- 7/24/18
Added 12v to 5v converter
- 3/9/19
Added audio transformer.
This is needed to isolate the Pi when the switching regulator is used
- 5/15/18
Added XLR cable to car 100

New Hope Valley Railway
N.C. Railroad Museum & East Carolina Chapter NRRHS

Train PA Amplifier Modifications

PA-105 Modified Rev 1.2 Drawn by: Ted Dunn
Approved by: *A. ...*